

Octacell meeting rooms

octacell

Soundproof workrooms  
that scale.



# What's Octacell?



## Scalable workrooms with **industry-leading** sound insulation



All Octacell spaces are made from the same elements



Fully modular, with customizable colors, materials and layout



A sound-insulated space for focused work, calls and confidential conversations



Efficient and quiet ventilation



Designed and manufactured in Finland

# Sizes for different needs

The element structure makes it easy to size the space for different uses and floor plans.

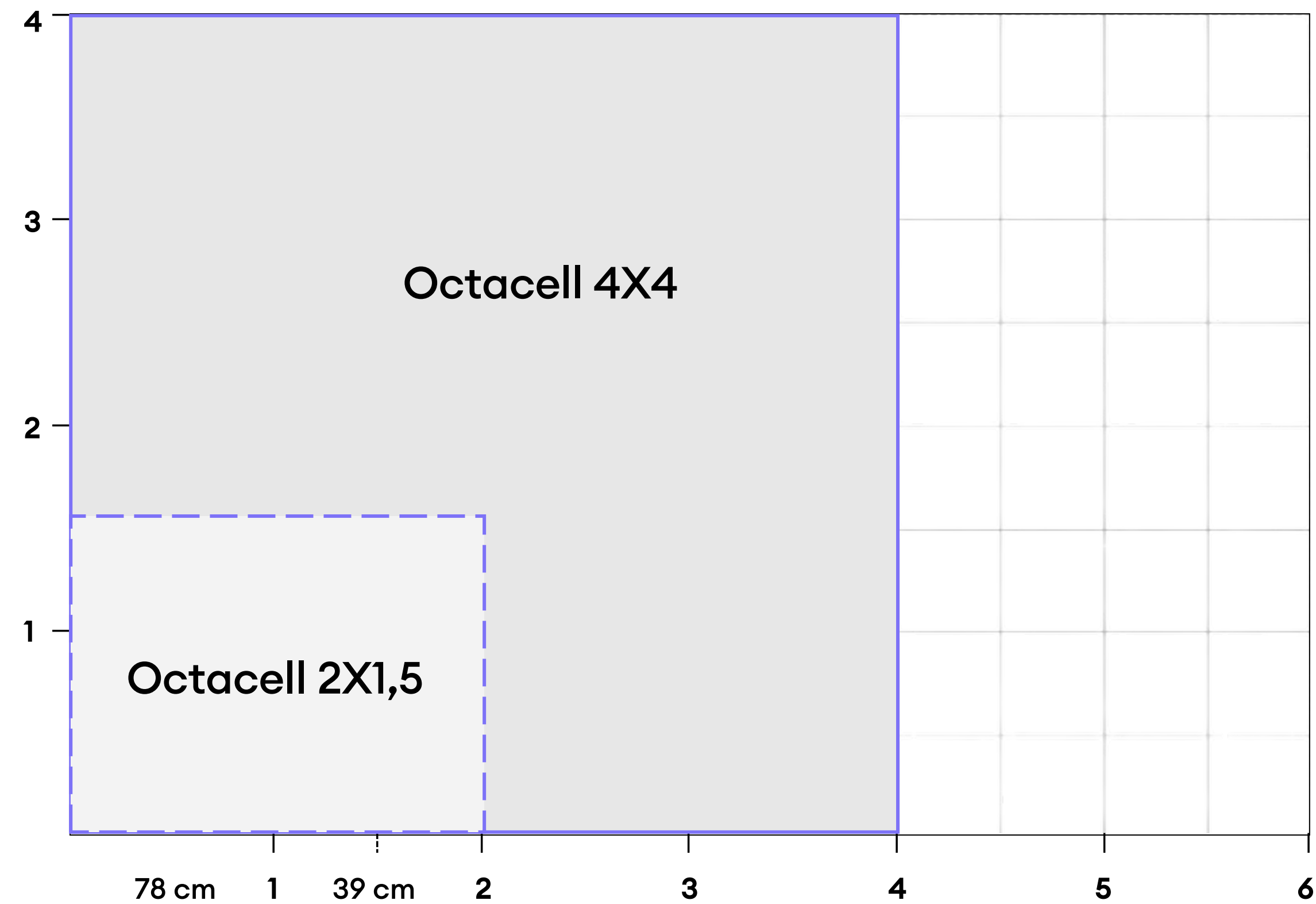

octacell



# Built to **scale** over time

The Octacell rooms can be modified, expanded and relocated even after installation.



## 1. Choose the right fit

Start with a solution that supports your current way of working.

## 2. Modify it later

The room can be resized or divided as requirements change. The materials and finishes can also be updated later.

## 3. Move to a new office

If your office moves, the Octacell room can be relocated to the new address.

# A more exact fit

In addition to standard sizes, Octacell rooms can be built with half-size elements.

Octacell 2X1

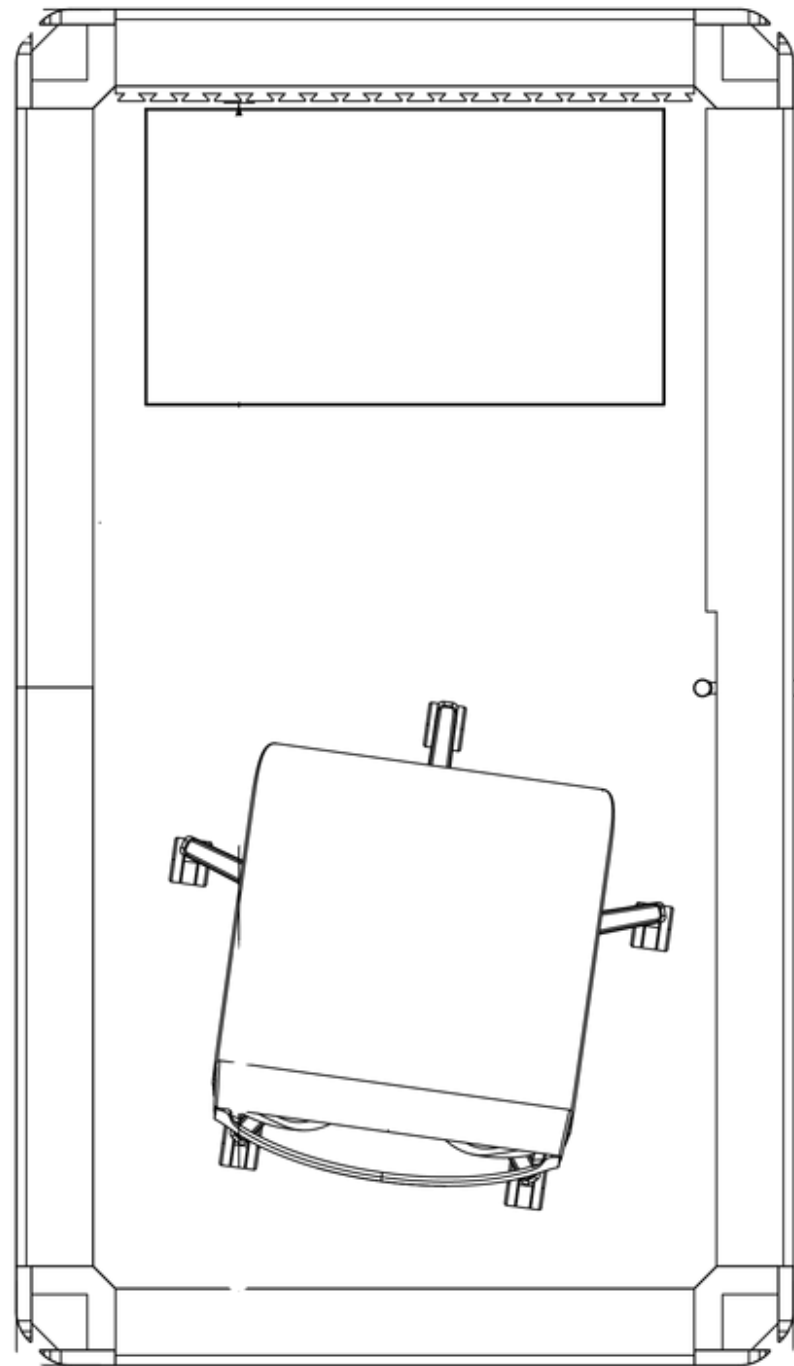

Octacell 2X1,5

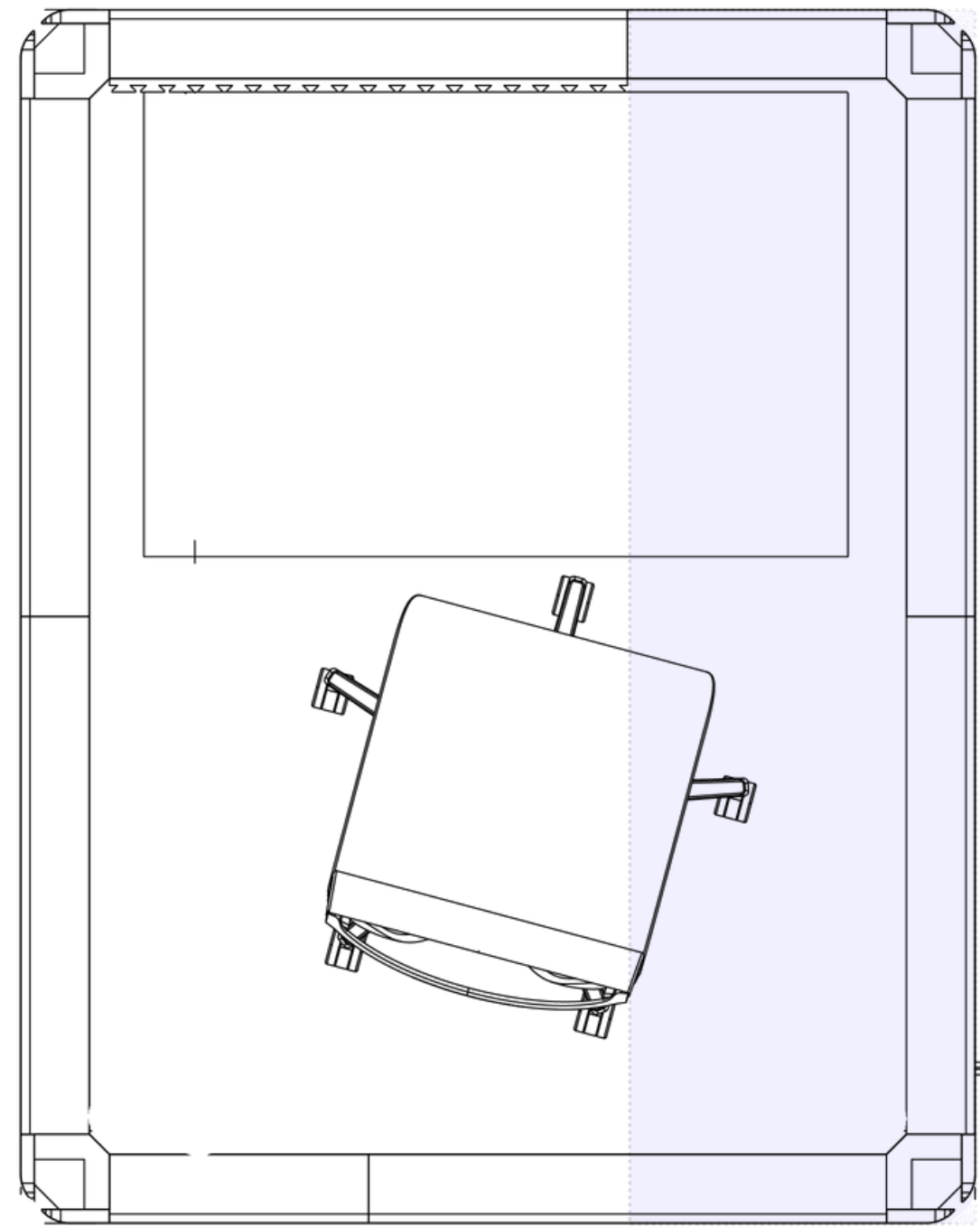

Octacell 2,5X1,5

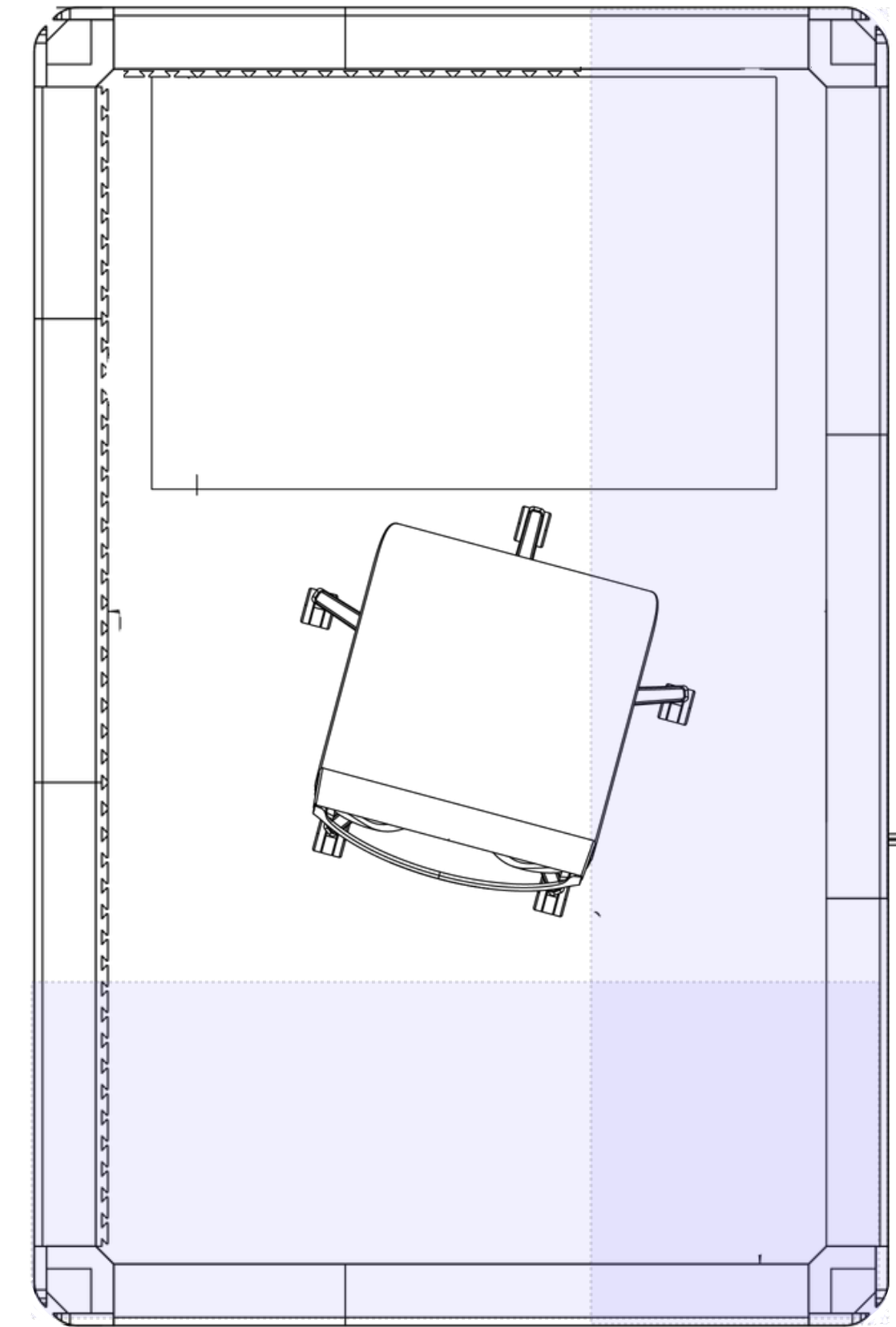

# Industry-leading sound insulation – tested and proven

Measurement standard: ISO 23351-1:2020

## 33,1 dB

Class A+

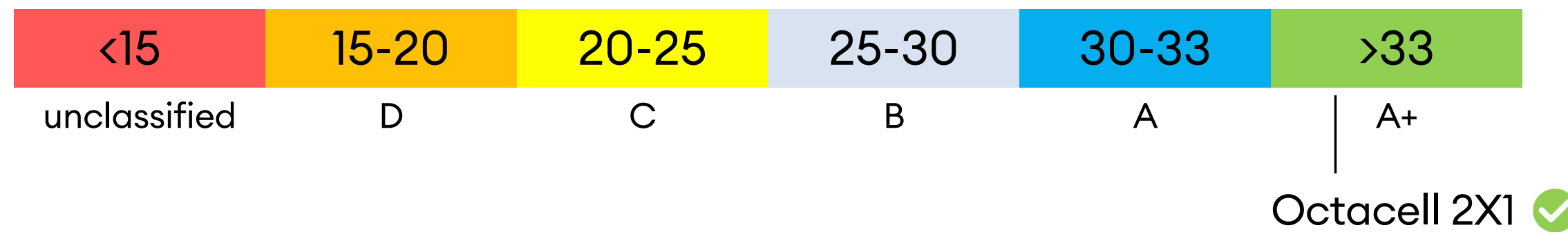

Determination of speech level reduction applying the methods of ISO 23351-1:2020 for field testing

**Speech level reduction  $D_{S,A}$  (field) 33,1 dB**

Calculated based on one-third octave band field measurements.

The results are only valid for the tested specimen configuration. Changes in size, geometry, or materials may lead to significant changes in reported results.

**SITOWISE** ..... +358 20 7118 590  
www.helmaki.fi • www.sitowise.com

octacell

Measurement standard: ISO 16283-1

## $D_{nT,w}$ [dB] = 44 dB

### 3.2 Results

Results for standardized level difference are listed in table 2 below.

**Table 2.** Measurement results of standardized level difference.

No.	Horizontal / Vertical	Source room	Receiving room	$D_{nT,w}$ [dB]
1	H	Office space	Octacell 4x4 with a sliding glass door	44

The results are only valid for the tested specimen configuration. Changes in size, geometry, or materials may lead to significant changes in measured results.



This document may only be presented or published in its entirety with the appendix.

SITOWISE AKUSTIIKKA  
sitowise.com/akustiikka  
020 7118 590

## $R'w$ [dB] = 41 dB

### 3.2 Results

Results for apparent sound reduction index are listed in table 2 below.

**Table 2.** Measurement results of of apparent sound reduction index.

No.	Horizontal / Vertical	Source room	Receiving room	$R'w$ [dB]
1	H	Office space	Octacell 4x4 with a sliding glass door	41

The results are only valid for the tested specimen configuration. Changes in size, geometry, or materials may lead to significant changes in measured results.



This document may only be presented or published in its entirety with the appendix.

SITOWISE AKUSTIIKKA  
sitowise.com/akustiikka  
020 7118 590

# Standard equipment

## Exterior



Water-based white paint

## Interior



Strip panel



Acoustic walls



Carpet floor

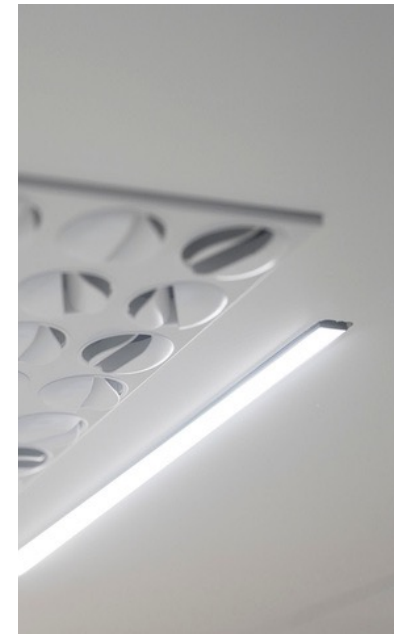

Painted ceiling

## Technology



Adjustable ventilation

Mechanical input and exhaust air

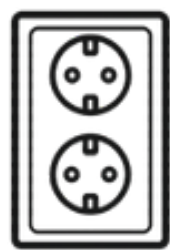

Power outlets

Outlets can be placed according to your needs



Adjustable LED lighting

Energy-efficient lighting

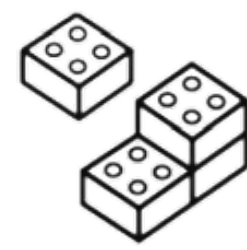

Modular design

Portable and convertible in one day



# Additional equipment

## Structural options



150 mm

### Ceiling height extension

The unit can be elevated by 150 mm, increasing interior height up to 2200 mm.

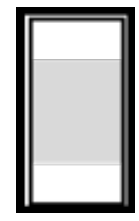

### Privacy solutions for glass surfaces

Glass surfaces can be fitted with privacy films and optional pleated blinds.



### Locking mechanisms

Supports various locking systems and optional access surveillance solutions.



### Fire suppression

Automated and independent fire suppression system.

## Interior & technology



### Furniture

Our spaces can be freely equipped with the furniture of your choosing.



### Audiovisual equipment

The rooms can be equipped with displays, reservation systems, integrated face lighting, and video conferencing solutions.



# Materials & finishes

Fully customizable  
inside and out

Create a workroom that  
fits your space seamlessly.

## Exterior finishes

Wood veneers



Oak



Birch

Painted surfaces (RAL)



Standard color

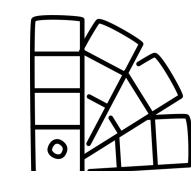

All RAL colors available

octacell

## Interior upholstery colors



Standard color



**Martindale > 100 000**  
High durability  
for demanding use.

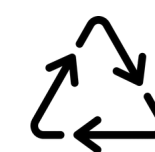

**Recycled wool**  
A responsible choice  
of material.



Explore the full collection at  
[nevotex.com](https://nevotex.com)

# Color combinations

Examples of color combinations where materials and tones work naturally together.



**Recycled wool**  
A responsible choice of material.



**Martindale > 100 000**  
High durability for demanding use.

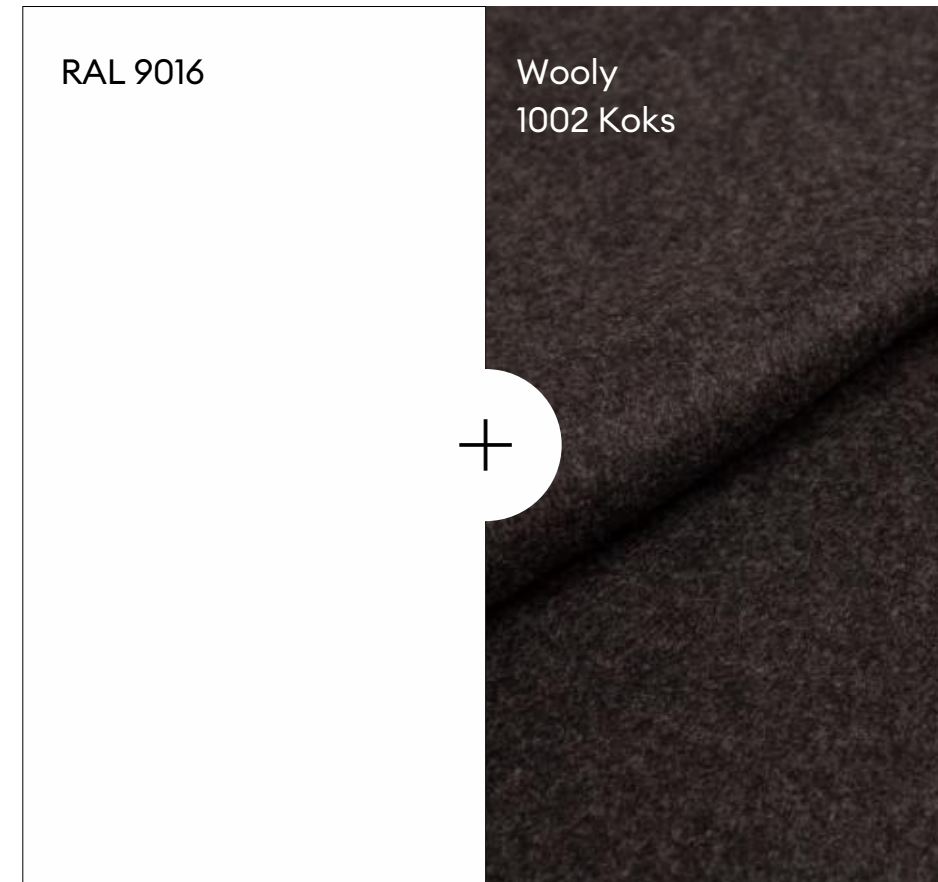

Standard colors

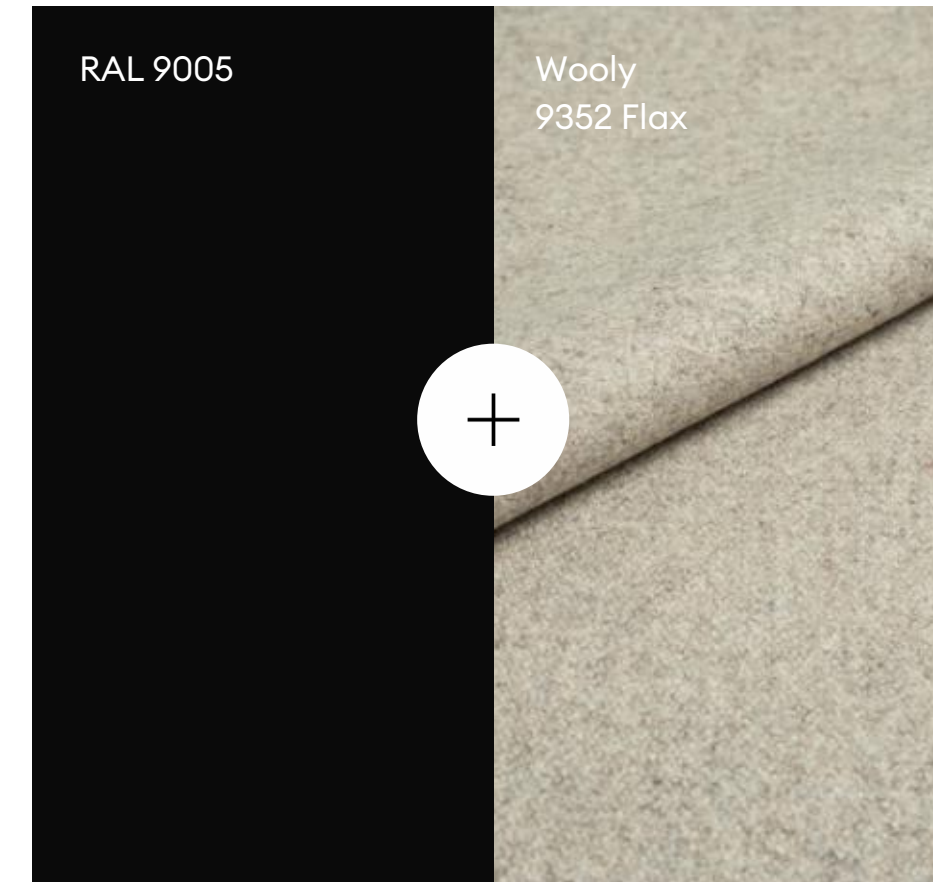

Soft contrast

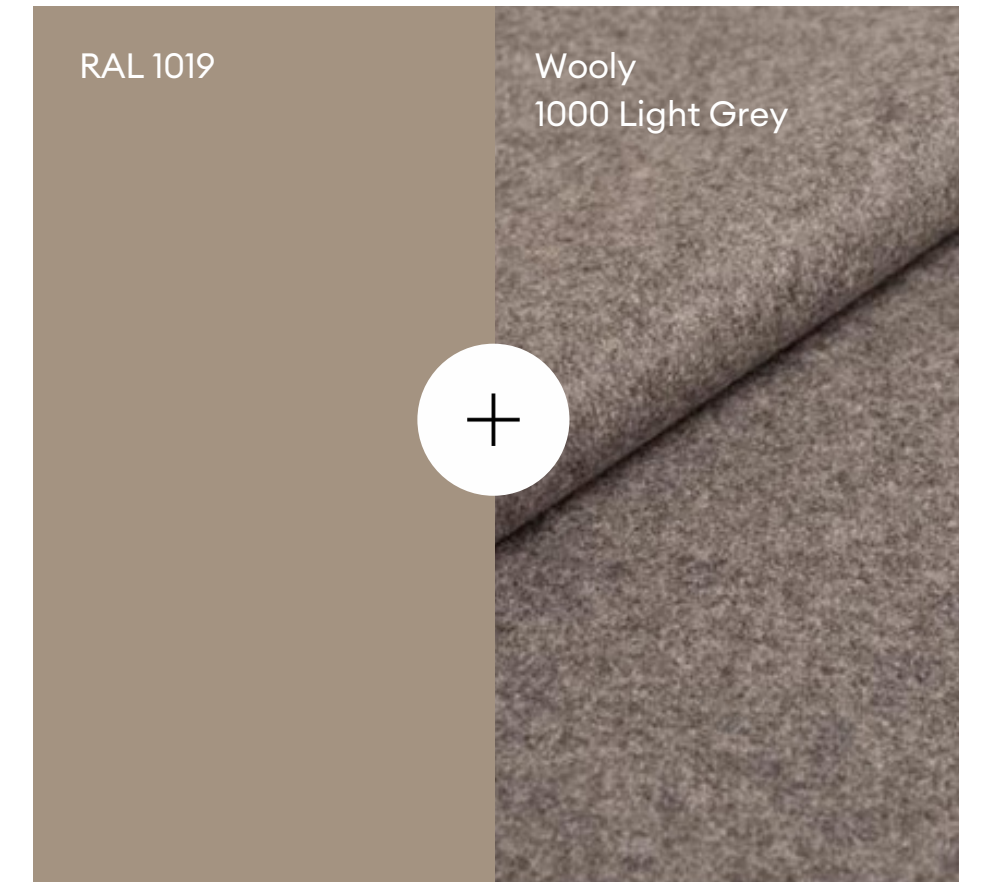

Sand



Forest green

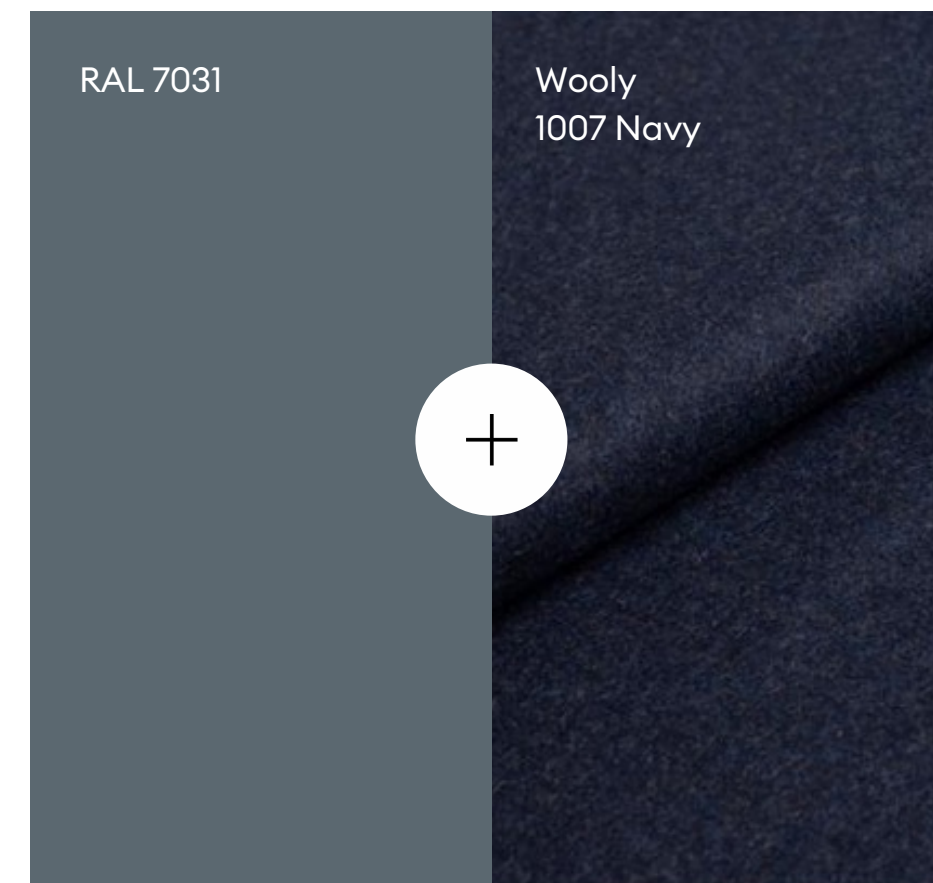

Blue grey

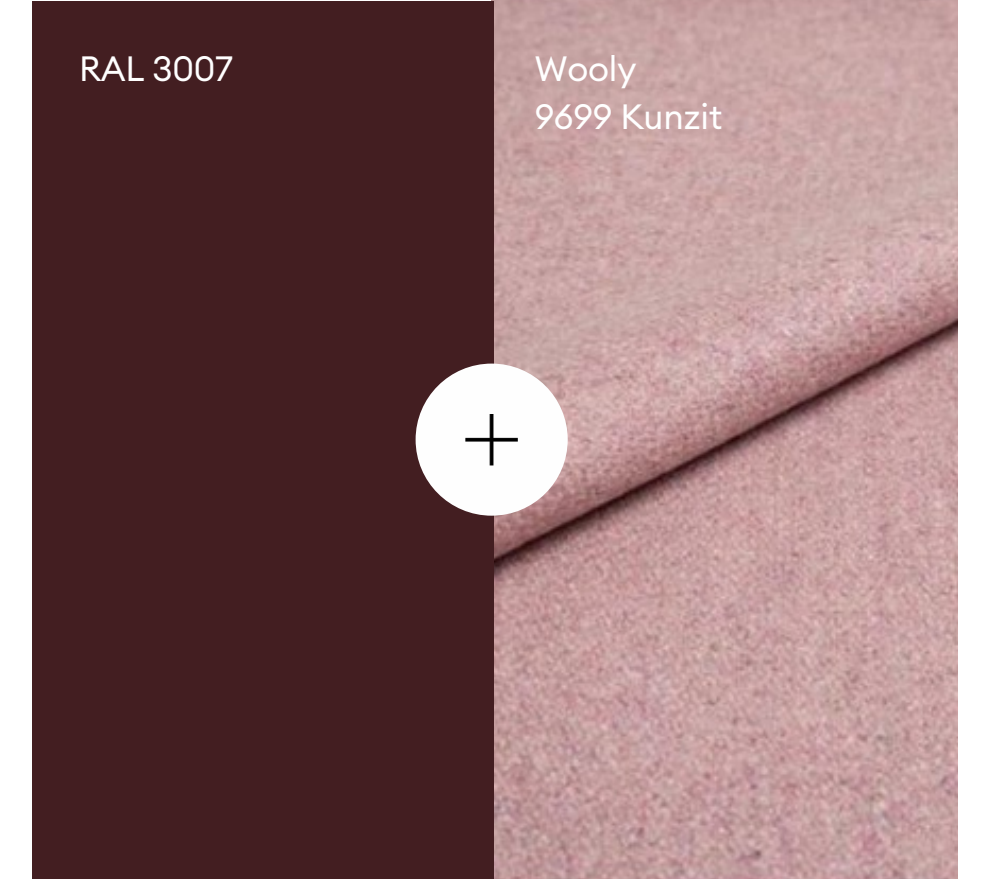

Dusty rose

# Octacell meeting rooms



# Meeting rooms

**3X1 (2,7 m<sup>2</sup>)**

Meeting room for two

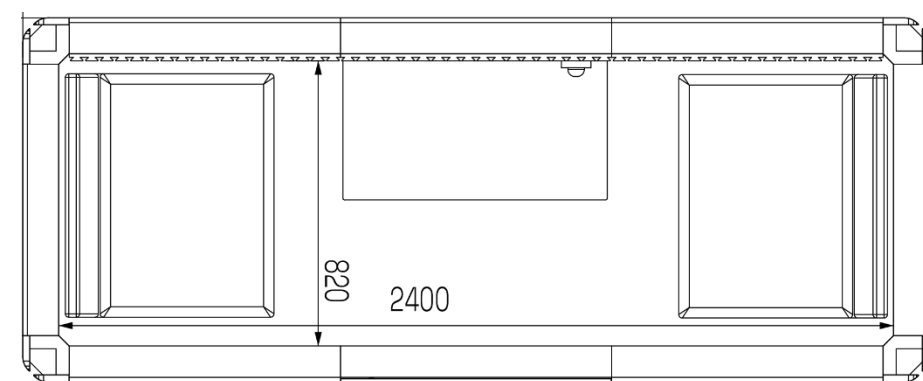

Outer dimensions:

2610 mm x 1050 mm x 2230 mm

Weight: 700 kg  
260 kg/m<sup>2</sup>

**3X2 (4,8 m<sup>2</sup>)**

Meeting room for four

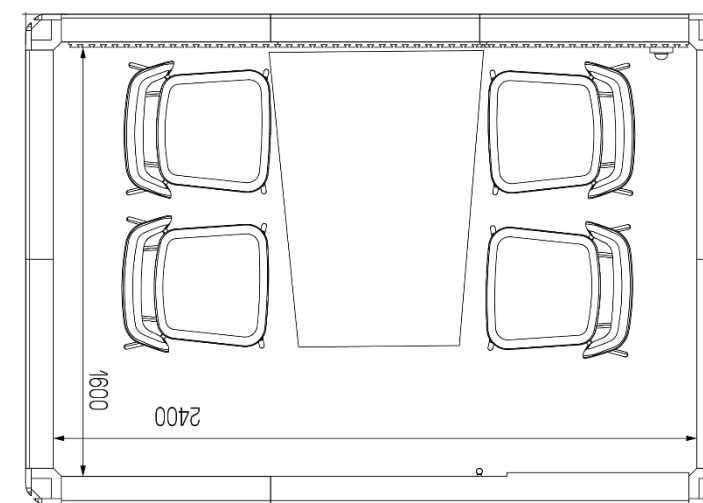

Outer dimensions:

2610 mm x 1830 mm x 2230 mm

Weight: 860 kg  
180 kg/m<sup>2</sup>

**3X3 (6,8 m<sup>2</sup>)**

Meeting room for 4-5 people

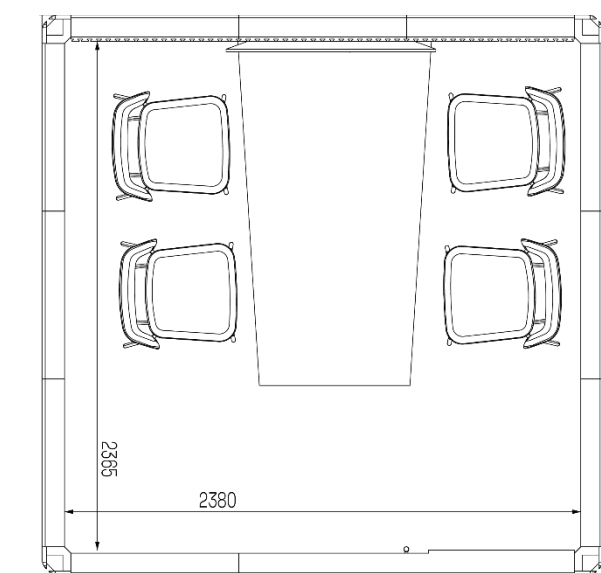

Outer dimensions:

2610 mm x 2610 mm x 2230 mm

Weight: 1000 kg  
147 kg/m<sup>2</sup>

# Meeting rooms

**4X3 (10 m<sup>2</sup>)**

Meeting room for six

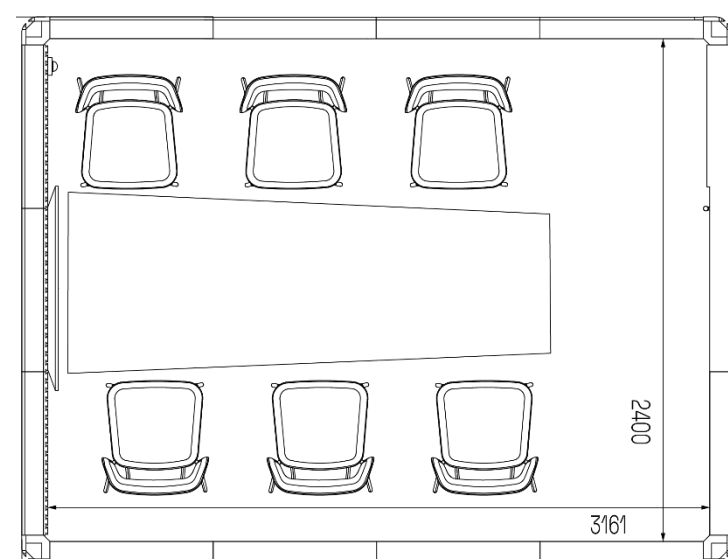

Outer dimensions:

3390 mm x 2610 mm x 2230 mm

Weight: 1170 kg  
117 kg/m<sup>2</sup>

**4X4 (11,5 m<sup>2</sup>)**

Meeting room for six

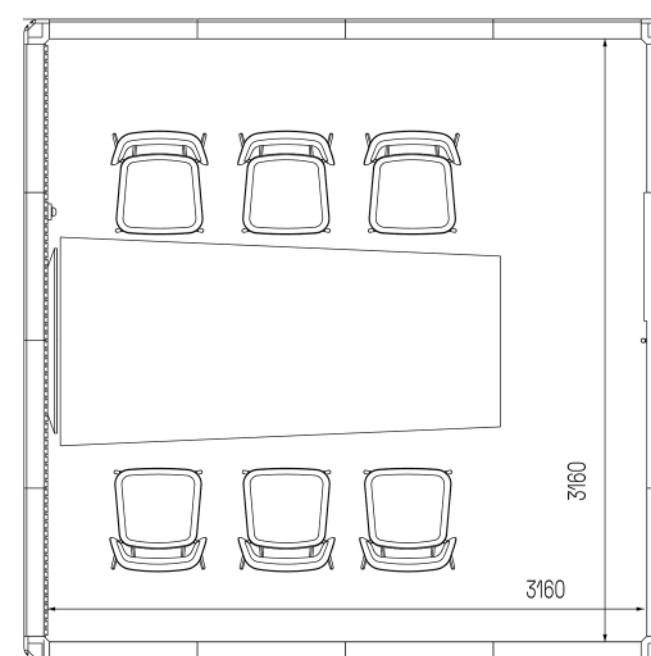

Outer dimensions:

3390 mm x 3390 mm x 2230 mm

Weight: 1400 kg  
122 kg/m<sup>2</sup>

**5X4 (14,1 m<sup>2</sup>)**

Meeting room for eight

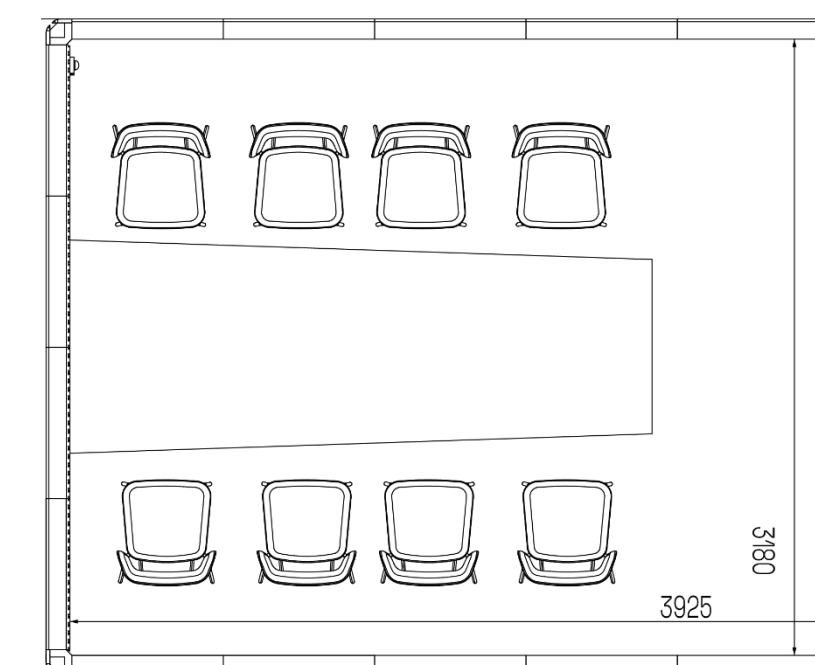

Outer dimensions:

4170 mm x 3390 mm x 2230 mm

Weight: 1630 kg  
116 kg/m<sup>2</sup>



Visit our showrooms and see the Octacell products in Helsinki, Tampere or Sweden

**Welcome!**



**Octacell Munkkivuori**  
Huopalahdentie 24  
00350 Helsinki

**Octacell Kamppi**  
Kansakoulukatu 3  
00100 Helsinki

**Octacell Tampere**  
Satakunnankatu 18 A  
33210 Tampere

**Octacell Stockholm**  
Birger Jarlsgatan 57  
113 56 Stockholm

octacell

# Certificates and Environmental Standards



## Sound Insulation

Sound-absorbing panel made from recycled polyester. The product is certified with the Allergy Label of the Finnish Allergy, Skin and Asthma Federation.

ISO 3795, FMVSS 302  
M1 emission classification



## Upholstery fabric

70 % recycled wool, 25 % Polyamide, 5 % blended fibres o REACH  
SFS-EN ISO 14184-1:en  
(GRS) Global Recycled standard



## Carpet – Interface Heuga

M1, GUT, GUI Standard, The product has the right to use the Allergy Label granted by the Finnish Allergy, Skin and Asthma Federation

BREEAM, BRE Green guide ratings, LEED US and International, HQE, DGNB Germany



## Paint

Waterborne  
Producer: Sherwin-Williams



## Frame

Mdf-panel Kronospan

- PEFC and FSC
- ISO 9001 and 14001
- All Kronospan wood panel products comply with the European E1\* safety standard

Birch plywood Koskisen or Metsä Wood  
ISO 9001 and 14001  
PEFC and FSC o E1

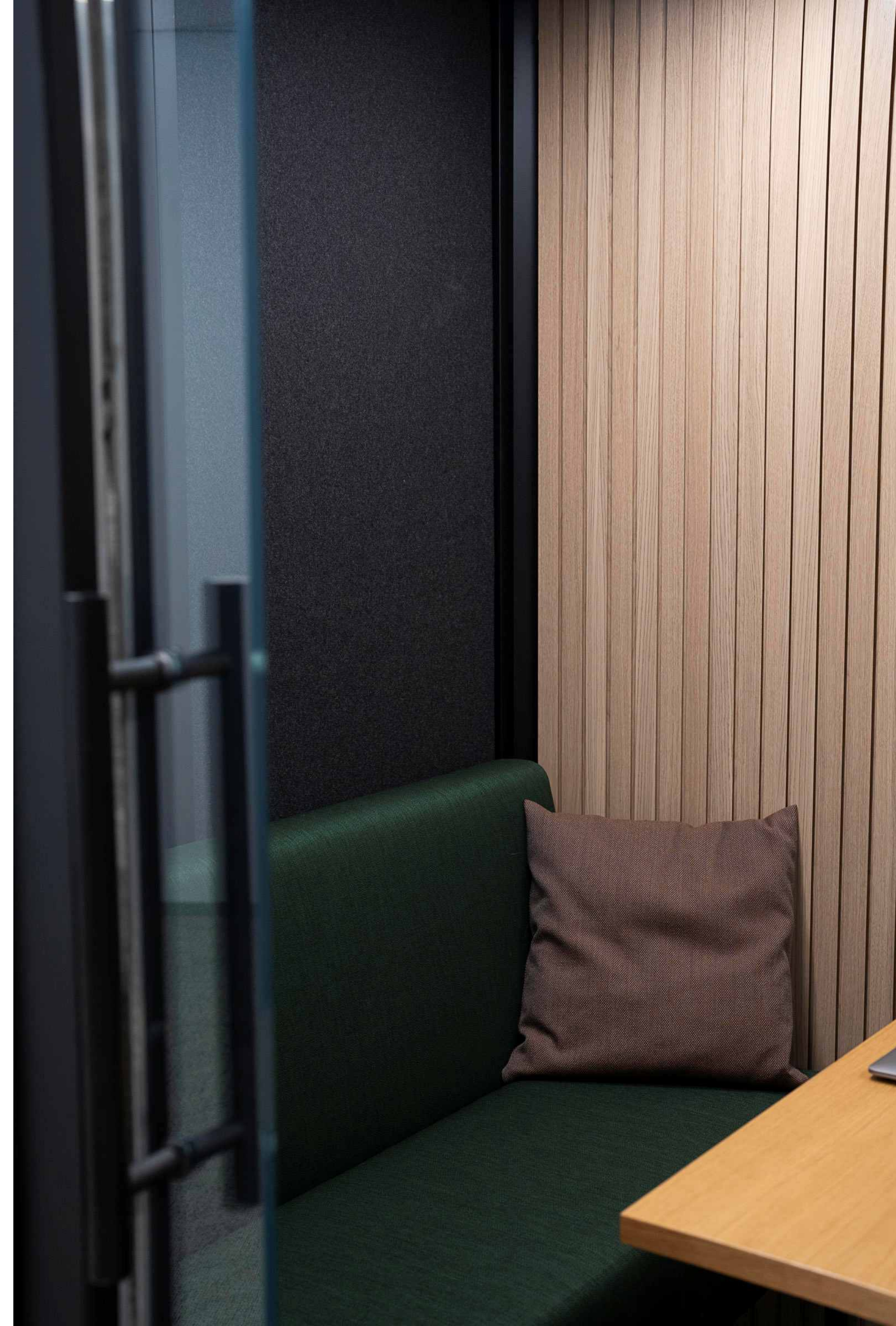



# octacell

Soundproof workrooms  
that scale.

Octacell Oy

+358 20 730 5380

[sales@octa.fi](mailto:sales@octa.fi)

Huopalahdentie 24, FI00350 Helsinki